

Model No.: **GP65AAAH**

Type	: Rechargeable Nickel Metal Hydride Cylindrical Cell
Nominal Dimension (with Sleeve)	: $\Phi = 10.5\text{mm}$ H = 43.7mm
Applications	: Recommended discharge current 65 to 1950mA
Nominal Voltage	: 1.2V
Capacity	: Nominal: 650mAh Minimum: 650mAh Typical: 680mAh When discharged at 130mA to 1.0V at 20°C
Charging Condition	: 65mA for 16 hrs at 20°C
Fast Charge	: 325mA to 650mA (0.5 to 1C) charge termination control recommended control parameters: - ΔV : 0-5mV **DT/dt : 0.8°C/min (0.5 to 0.9C) 0.8 - 1°C/min (1C) **TCO : 45 - 50°C **Timer : 105% nominal input ** for ref. only
Service Life	: >500 cycles (IEC standard)
Continuous Overcharge	: 65mA maximum current for 9 months. No conspicuous deformation and/or leakage
Weight	: 13.0g
Internal Resistance	: Average 35m Ω upon fully charged (Range 20 - 50m Ω) at 1000Hz
Max. Charging Voltage	: 1.5V at 65mA charging
Ambient Temperature Range	: Standard Charge : 0 to 45°C Fast Charging : 10 to 45°C Discharge : -20 to 50°C Storage : -20 to 35°C

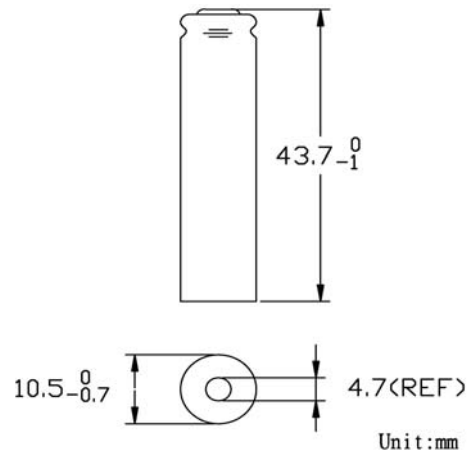

Low Rate Discharge

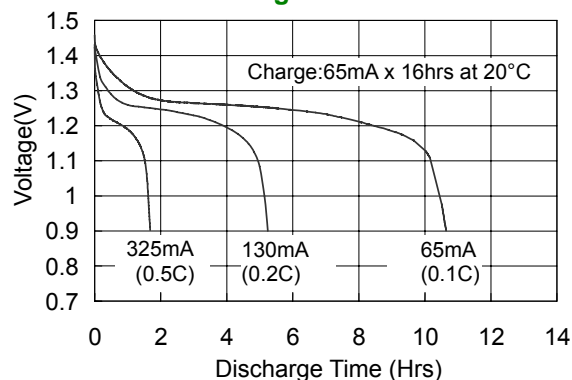

High Rate Discharge

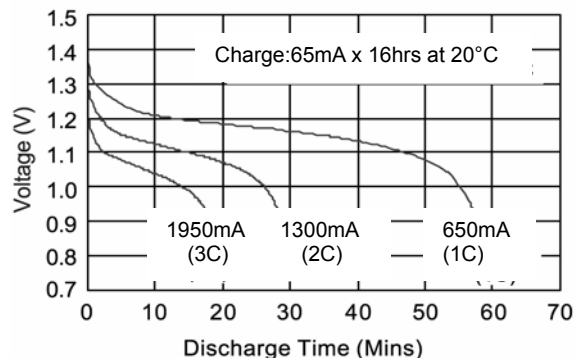

Fast Charge (Charge control required)

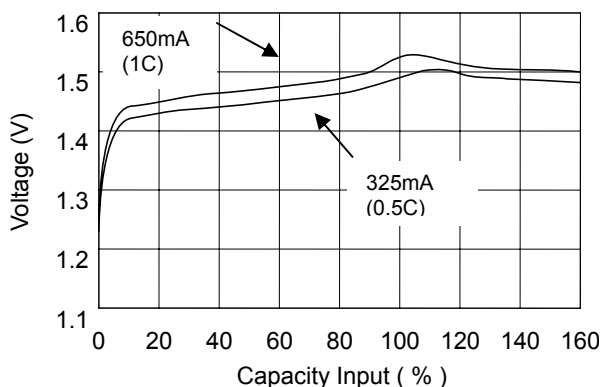

The information (subject to change without prior notice) contained in this document is for reference only and should not be used as a basis for product guarantee or warranty. For applications other than those described here, please consult your nearest GP Sales and Marketing Office or Distributors.